

Motorized Cellular Shades Top Down-Bottom Up Type Instruction Manual

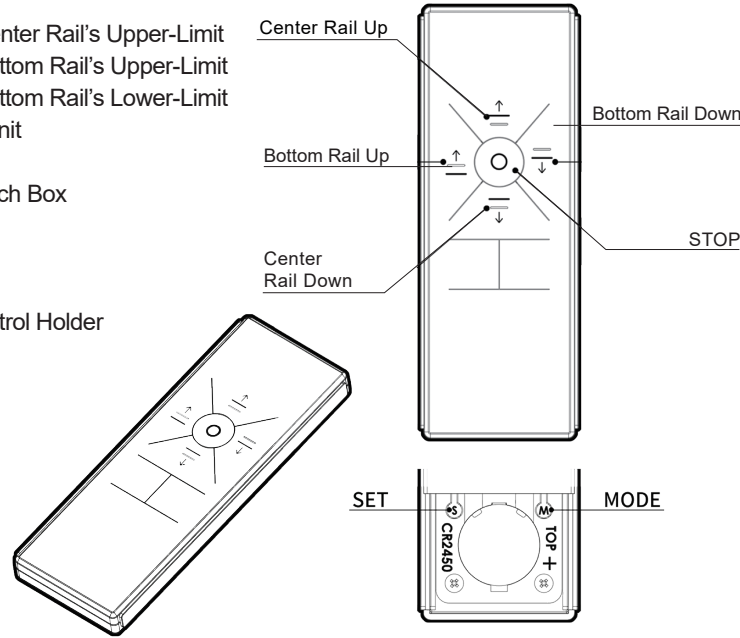
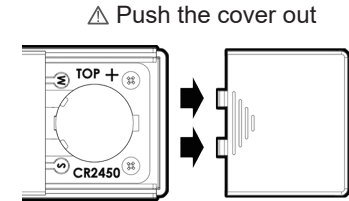

Table of Contents

- 1-1 Setting or modifying position of Center Rail's Upper-Limit
- 1-2 Setting or modifying position of Bottom Rail's Upper-Limit
- 1-3 Setting or modifying position of Bottom Rail's Lower-Limit
- 2-1 Adding another Remote Control Unit
- 3-1 Clear off Password
- 4-1 Externally connected Manual Switch Box
- 5-1 Battery Replacement
- 5-2 Product Specifications
- 5-3 Quick Setting Index
- 5-4 Instructions for using Remote Control Holder



How to open Battery Compartment Cover



How to replace Battery Compartment Cover

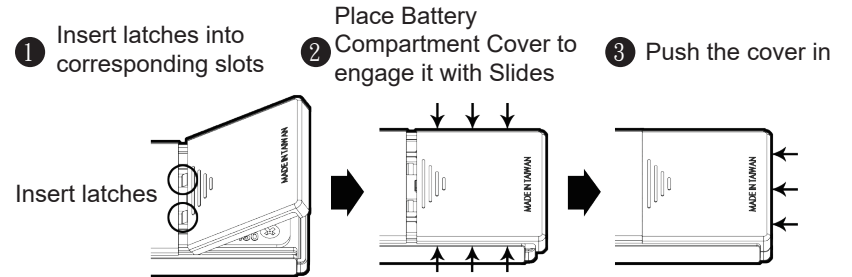

Reminders before Making Settings

- 1 Please follow this sequence of steps when setting: 1-1, 1-2 and 1-3.
- 2 If 6 beep sounds occur during the setting, it means that the steps are not finished yet, it might be Center Rail's Upper-Limit (step 1-1), Bottom Rail's Upper-Limit (step 1-2) or Bottom Rail's Lower-Limit (step 1-3).

1-1 Setting or modifying position of Center Rail's Upper-Limit

STEP-1 Press and hold [CENTER RAIL UP] + [SET] keys until 4 short beep sounds occur, indicating that the setting mode of Center Rail's Upper-Limit is activated.

STEP-2 Press [CENTER RAIL UP] OR [CENTER RAIL DOWN] key to move the Center Rail of the Cellular Shade to a pre-determined position, to be set as the Upper-Limit.

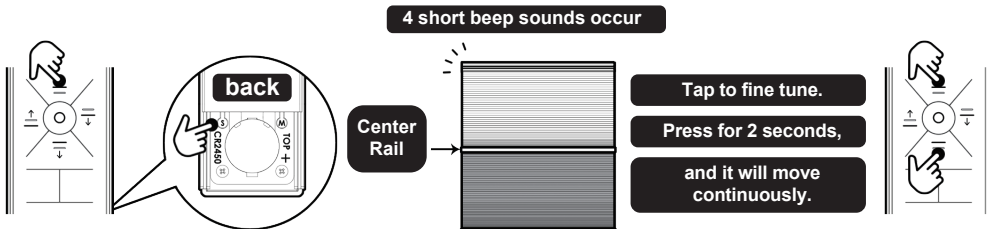

CAUTION

While the Cellular Shade is getting close to reaching the Upper-Limit, please press [STOP] to stop the movement to avoid damage to the motor. Then, tap to fine tune to the place where you would like it to be set as the Upper-Limit.

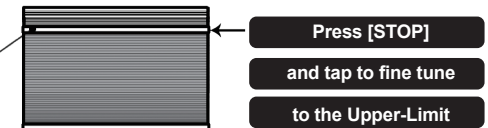

Motorized Cellular Shades Top Down-Bottom Up Type Instruction Manual



STEP-3

When the pre-determined position is reached, press [STOP] key once to stop the movement; then, press [BOTTOM RAIL UP] + [SET] OR [BOTTOM RAIL DOWN] + [SET] to confirm; the setting is completed when a long beep sound occurs.

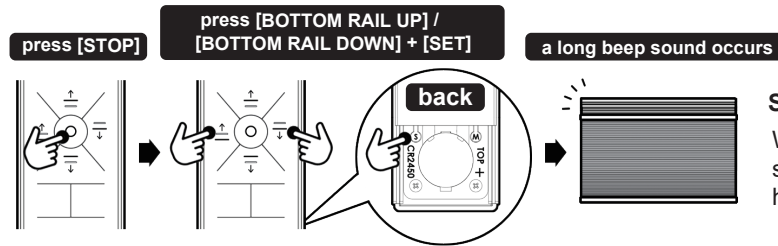

Setting Completed

When everything is done, the Center Rail's Upper-Limit setting is completed, too. And the setting of Lower-Limit has been cleared as well.

1-2 Setting or modifying position of Bottom Rail's Upper-Limit

STEP-1

Press and hold [CENTER RAIL UP] + [SET] keys until 4 short beep sounds occur; then, press them again until 2 short beep sounds occur, indicating that the setting mode of Bottom Rail's Upper-Limit is activated.

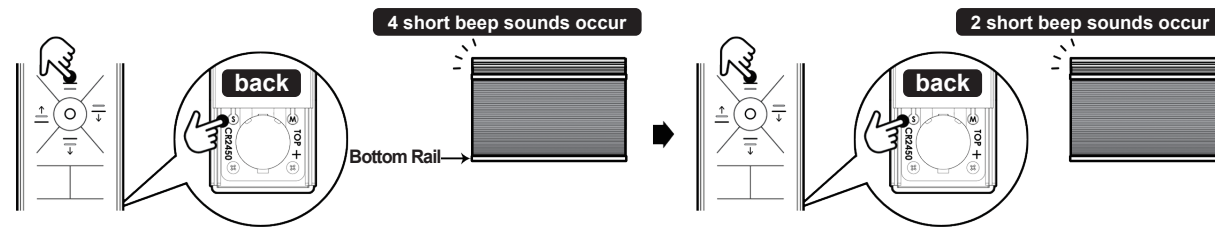

STEP-2

Press and hold [CENTER RAIL UP] OR [CENTER RAIL DOWN] key to move the Bottom Rail of the Cellular Shade to a pre-determined position, to be set as the Upper-Limit.

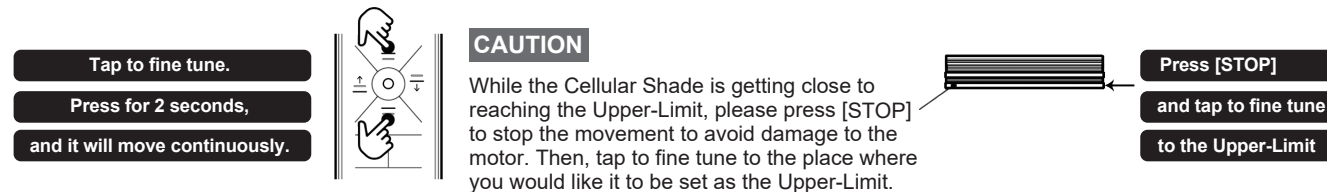



STEP-3 When the pre-determined position is reached, press [STOP] key once to stop the movement; then, press [BOTTOM RAIL UP] + [SET] OR [BOTTOM RAIL DOWN] + [SET] to confirm; the setting is completed when a long beep sound occurs.

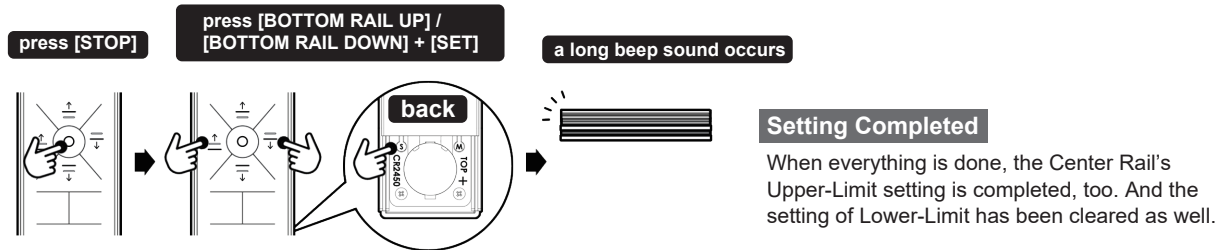

1-3 Setting or modifying position of Bottom Rail's Lower-Limit

STEP-1 Press and hold [CENTER RAIL DOWN] + [SET] keys until 5 short beep sounds occur, indicating that the setting mode of Bottom Rail's Lower-Limit is activated.

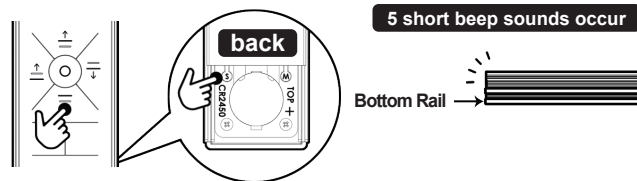

STEP-2 Press and hold [CENTER RAIL UP] OR [CENTER RAIL DOWN] key to move the Bottom Rail of the Cellular Shade to a pre-determined position, to be set as the Lower-Limit.

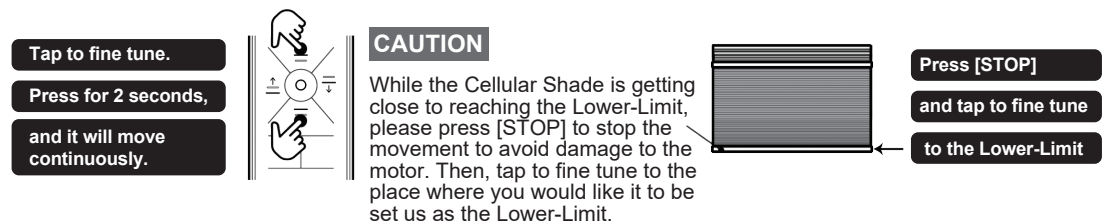

STEP-3 When the pre-determined position is reached, press [STOP] key once to stop the movement; then, press [BOTTOM RAIL UP] + [SET] OR [BOTTOM RAIL DOWN] + [SET] to confirm; the setting is completed when a long beep sound occurs.

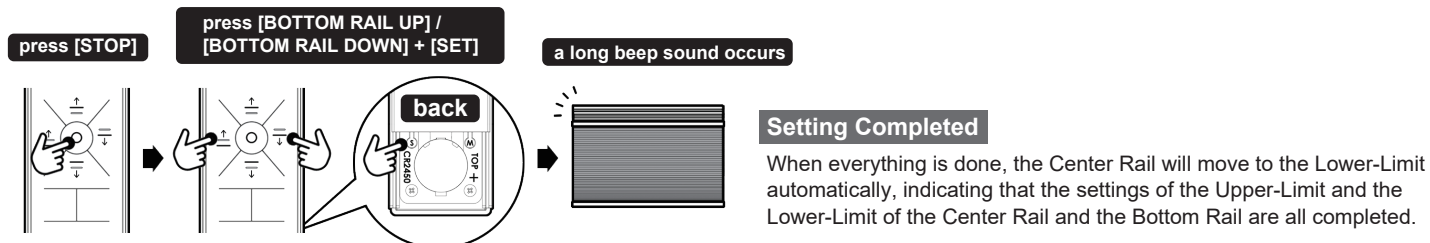



2-1 Adding another Remote Control Unit

STEP-1 Press and hold [SET] + [STOP] until 3 short beep sounds occur, indicating that the setting mode of Adding another Remote Control Unit is activated.

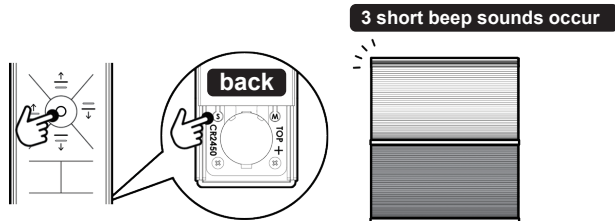

STEP-2 Now press [STOP] key of the Remote Control to be added; the adding process is completed when a short beep sound occurs.

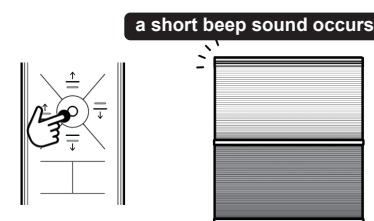

Setting Completed

When everything is done, a long beep sound will occur, indicating that the setting mode is deactivated.

3-1 Clear off Password

STEP-1 Unplug power supply of the Motor, wait for 15 seconds, resume power supply of it. Press [CENTER RAIL UP] + [STOP] + [CENTER RAIL DOWN] + [BOTTOM RAIL UP] OR [BOTTOM RAIL DOWN] altogether 4 keys, beep sounds will occur immediately, within 5 seconds, press [CENTER RAIL UP] + [CENTER RAIL DOWN]. Password is cleared off when the beeping sounds stop.

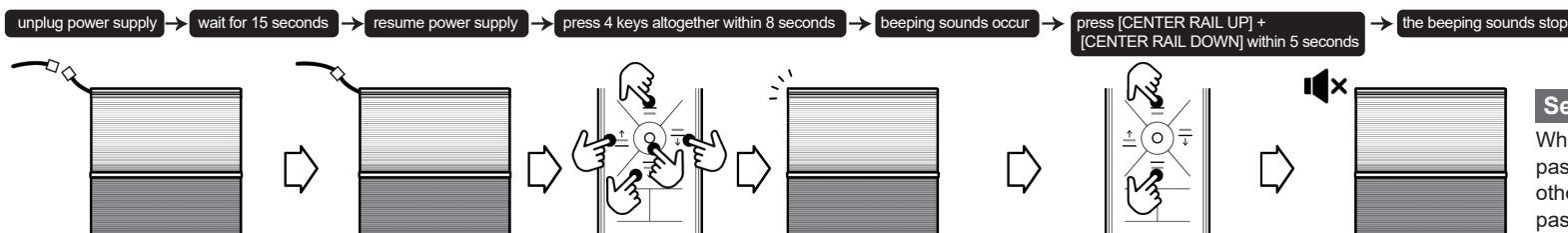

Setting Completed

When everything is done, only the password of this remote remains, others will be erased. If a new password is not added, the old password will not be erased.



4-1 Externally connected Manual Switch Box

The procedures are the same as the above remote setting mode (step 1-1 ~ 1-3).

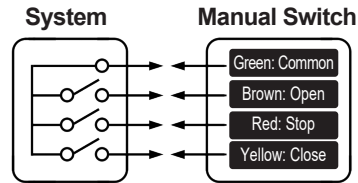
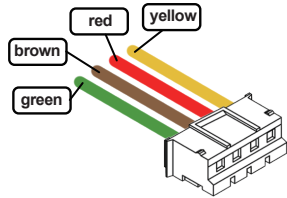

A brief contact will activate the function;
DO NOT short-circuit continuously.

Instructions

- Green** = Common
- Green + Red** = Stop
- Green + Brown** = Center Rail Up
- Green + Yellow** = Center Rail Down
- Green + Brown + Red** = Bottom Rail Up
- Green + Yellow + Red** = Bottom Rail Down

5-1 Battery Replacement

- 1 With flat side (positive +) of the Battery facing upwards, making sure that the Battery is latched up by two spring plates, insert Battery in a slanted angle to enter it into the Battery Holder.

flat side (positive +)



- 2 Completed.

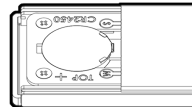

5-2 Product Specifications

- Battery:** CR2450 3V (One-time type lithium battery)
- Dimensions:** L 13CM, W 4.8CM, H 1.1CM
- Standby Current:** <1uA
- Modulation Method:** OOK
- Encoding Method:** Internally-burnt fixed coding
- Transmission Frequency:** 433.92 MHz
- Antenna Type:** on board, Gain=0 dbi
- Weight (including battery):** 66g



5-3 Quick Setting Index

Setting or modifying position of Center Rail's Upper-Limit : [SET] + [CENTER RAIL UP]

Setting or modifying position of Bottom Rail's Upper-Limit : [SET] + [CENTER RAIL UP] X2

Setting or modifying position of Bottom Rail's Lower-Limit : [SET] + [CENTER RAIL DOWN]

Adding another Remote Control Unit : [SET] + [STOP], (Remote Control 2) [Stop]

Clear off Password: [CENTER RAIL UP] + [STOP] + [CENTER RAIL DOWN] + [BOTTOM RAIL UP]
OR [BOTTOM RAIL DOWN], [BOTTOM RAIL UP] + [BOTTOM RAIL DOWN]

5-4 Instructions for using Remote Control Holder

Vertical Holder

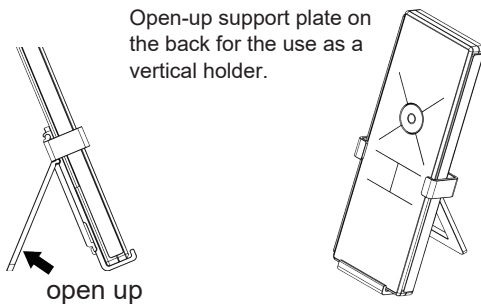

Open-up support plate on the back for the use as a vertical holder.

Wall-mount Holder

Apply the provided double-face adhesive tape on the back of Holder and stick it onto the desired position on the wall, as a wall-mounted holder.

Apply the adhesive tape

